

## 23V, 3.5A, 340KHz Synchronous Step-Down DC/DC Converter

### Description

The FR9888 is a synchronous step-down DC/DC converter that provides wide 4.5V to 23V input voltage range and 3.5A continuous load current capability.

The FR9888 fault protection includes cycle-by-cycle current limit, input UVLO, output over voltage protection and thermal shutdown. Besides, adjustable soft-start function prevents inrush current at turn-on. This device uses current mode control scheme which provides fast transient response. Internal Compensation function reduces external compensation components and simplifies the design process. In shutdown mode, the supply current is less than 1µA.

The FR9888 is available in an 8-pin SOIC package, provides a very compact system solution and good thermal conductance.

### Features

- High Efficiency up to 96%
- Low Rds(on) Integrated Power MOSFET
- Internal Compensation Function
- Wide Input Voltage Range: 4.5V to 23V
- Adjustable Output Voltage Range: 0.925V to 20V
- 3.5A Output Current
- Fixed 340KHz Switching Frequency
- Current Mode Operation
- Adjustable Soft-Start
- Cycle-by-Cycle current limit
- Input Under Voltage Lockout
- Over-Temperature Protection with Auto Recovery
- <1µA Shutdown Current
- SOP-8 Exposed Pad Package

### Applications

- Set-Top-Box (STB)
- Television
- Distributed Power System
- XDSL Modem

### Pin Assignments

SP Package (SOP-8 Exposed Pad )

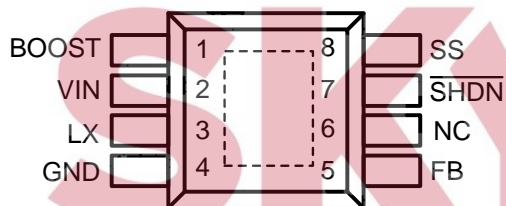
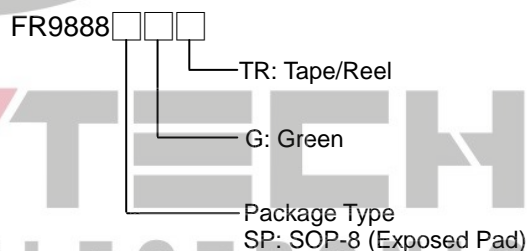

Figure 1. Pin Assignment of FR9888

### Ordering Information



**Typical Application Circuit**

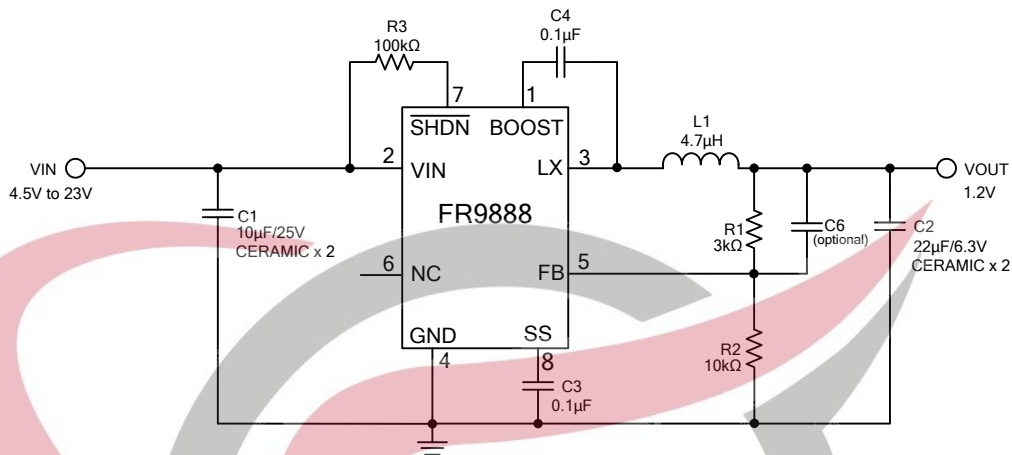

Figure 2.  $C_{IN}/C_{OUT}$  use Ceramic Capacitors Application Circuit

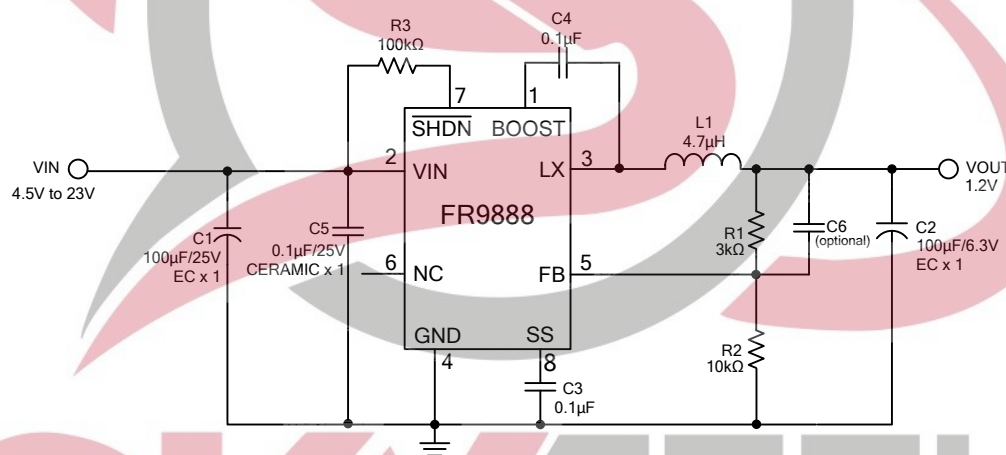

Figure 3.  $C_{IN}/C_{OUT}$  use Electrolytic Capacitors Application Circuit

$V_{OUT}$	R1	R2	C6	L1	$C_{OUT}$
1.2V	3kΩ	10kΩ	200pF~1nF	4.7μH	22μF MLCC x2
1.8V	9.53kΩ	10kΩ	200pF~1nF	4.7μH	22μF MLCC x2
2. V	16.9kΩ	10kΩ	200pF~1nF	10μH	22μF MLCC x2
3.3V	26.1kΩ	10kΩ	200pF~1nF	10μH	22μF MLCC x2
5V	44.2kΩ	10kΩ	200pF~1nF	10μH	22μF MLCC x2
1.2V	3kΩ	10kΩ	--	4.7μH	100μF EC x1
1.8V	9.53kΩ	10kΩ	--	4.7μH	100μF EC x1
2.5V	16.9kΩ	10kΩ	--	10μH	100μF EC x1
3.3V	26.1kΩ	10kΩ	--	10μH	100μF EC x1
5V	44.2kΩ	10kΩ	--	10μH	100μF EC x1

Table 1. Recommended Component Values

### Functional Pin Description

I/O	Pin Name	Pin No.	Pin Function
I	FB	5	Voltage Feedback Input Pin. Connect FB and $V_{OUT}$ with a resistive voltage divider. This IC senses feedback voltage via FB and regulates it at 0.925V.
I	VIN	2	Power Supply Input Pin. Drive this pin by 4.5V to 23V voltage to power on the chip.
I	$\overline{\text{SHDN}}$	7	Enable Input Pin. This pin provides a digital control to turn the converter on or off. Connect VIN with a 100K $\Omega$ resistor for self-startup.
I	GND	4	Ground Pin. Connect this pin to exposed pad.
O	LX	3	Power Switching Output. It is the output pin of internal high side NMOS which is the switching to supply power.
O	SS	8	Soft-Start Pin. This pin controls the soft-start period. Connect a capacitor from SS to GND to set the soft start period.
O	BOOST	1	High Side Gate Drive Boost Pin. A 10nF or greater capacitor must be connected from this pin to LX. It can boost the gate drive to fully turn on the internal high side NMOS.
O	NC	6	No connection. Keeps this pin floating.

### Block Diagram

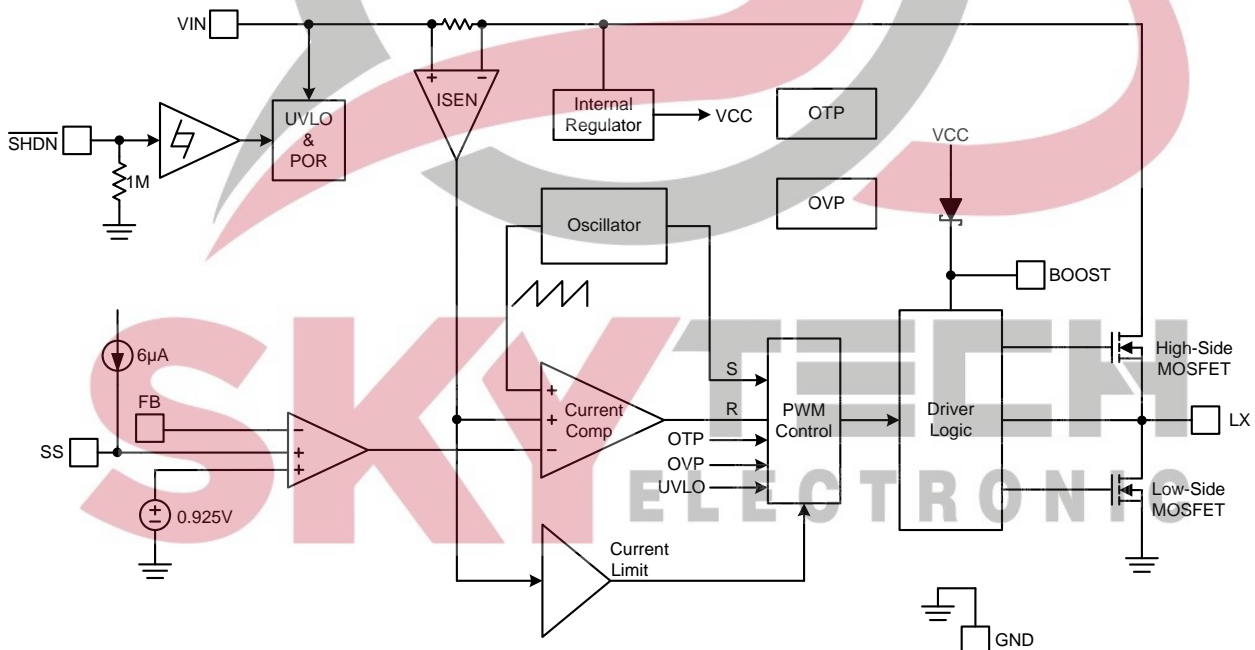

Figure 4. Block Diagram of FR9888

**Absolute Maximum Ratings** (Note1)

- Supply Voltage  $V_{IN}$  ----- -0.3V to +25V
- Enable Voltage  $V_{SHDN}$  ----- -0.3V to +25V
- LX Voltage  $V_{LX}$  (50ns) ----- -1V to  $V_{IN}+0.3V$
- Boost Trap Voltage  $V_{BOOST}$  -----  $V_{LX}-0.3V$  to  $V_{LX}+6V$
- All Other Pins Voltage ----- -0.3V to +6V
- Maximum Junction Temperature ( $T_J$ ) ----- +150°C
- Storage Temperature ( $T_S$ ) ----- -65°C to +150°C
- Lead Temperature (Soldering, 10sec.) ----- +260°C
- Power Dissipation @ $T_A=25^\circ C$ , ( $P_D$ ) (Note2)
  - SOP-8 (Exposed Pad) ----- 2.08W
- Package Thermal Resistance, ( $\theta_{JA}$ ):
  - SOP-8 (Exposed Pad) ----- 60°C/W
- Package Thermal Resistance, ( $\theta_{JC}$ ):
  - SOP-8 (Exposed Pad) ----- 15°C/W

Note 1 : Stresses beyond this listed under "Absolute Maximum Ratings" may cause permanent damage to the device.  
 Note 2 : PCB heat sink copper area = 10mm<sup>2</sup>.

**Recommended Operating Conditions**

- Supply Voltage  $V_{IN}$  ----- +4.5V to +23V
- Enable Voltage  $V_{SHDN}$  ----- 0V to  $V_{IN}$
- Operation Temperature Range ----- -40°C to + 85°C



## Electrical Characteristics

( $V_{IN}=12V$ ,  $T_A=25^{\circ}C$ , unless otherwise specified.)

Parameter	Symbol	Conditions	Min	Typ	Max	Unit
$V_{IN}$ Input Supply Voltage	$V_{IN}$		4.5		23	V
$V_{IN}$ Quiescent Current	$I_{DDQ}$	$V_{SHDN}=1.8V$ , $V_{FB}=1.0V$		2.5		mA
$V_{IN}$ Shutdown Supply Current	$I_{SD}$	$V_{SHDN}=0V$			1	$\mu A$
Feedback Voltage	$V_{FB}$	$4.5V \leq V_{IN} \leq 23V$	0.9	0.925	0.95	V
Feedback OVP Threshold Voltage	$V_{OVP}$			1.5		V
High-Side MOSFET $R_{DS(ON)}$ (Note3)	$R_{DS(ON)}$			110		m $\Omega$
Low-Side MOSFET $R_{DS(ON)}$ (Note3)	$R_{DS(ON)}$			80		m $\Omega$
High-Side MOSFET Leakage Current	$I_{LX(leak)}$	$V_{SHDN}=0V$ , $V_{LX}=0V$			10	$\mu A$
High-Side MOSFET Current Limit (Note3)	$I_{LIMIT(HS)}$	Minimum Duty	4	5		A
Low-Side MOSFET Current Limit (Note3)	$I_{LIMIT(LS)}$	From Drain to Source		1.5		A
Error Amplifier Voltage Gain (Note3)				400		V/V
Oscillation frequency	$F_{OSC}$		290	340	420	KHz
Short Circuit Oscillation Frequency	$F_{OSC(short)}$	$V_{FB}=0V$		110		KHz
Maximum Duty Cycle	$D_{MAX}$	$V_{FB}=0.8V$		90		%
Minimum On Time (Note3)	$T_{MIN}$			100		ns
Input UVLO Threshold	$V_{UVLO(Vth)}$	$V_{IN}$ Rising		4.3		V
Under Voltage Lockout Threshold Hysteresis	$V_{UVLO(HYS)}$			250		mV
Soft-Start Current	$I_{SS}$	$V_{SS}=0V$		6		$\mu A$
Soft-Start Period	$T_{SS}$	$C_{SS}=0.1\mu F$		15		ms
$\overline{SHDN}$ Input Low Voltage	$V_{SHDN(L)}$				0.4	V
$\overline{SHDN}$ Input High Voltage	$V_{SHDN(H)}$		2			V
$\overline{SHDN}$ Input Current	$I_{SHDN}$	$V_{SHDN}=2V$		2		$\mu A$
Thermal Shutdown Threshold (Note3)	$T_{SD}$			170		$^{\circ}C$

Note 3 : Not production tested.

## Typical Performance Curves

$V_{IN} = 12V$ ,  $V_{OUT} = 3.3V$ ,  $C1 = 10\mu F \times 2$ ,  $C2 = 22\mu F \times 2$ ,  $L1 = 10\mu H$ ,  $T_A = +25^\circ C$ , unless otherwise noted.

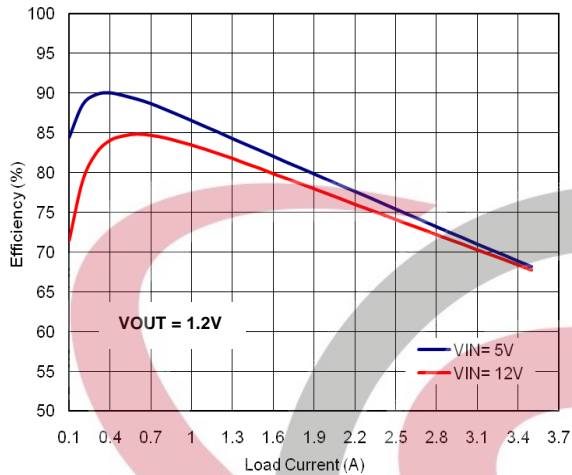

Figure 5. Efficiency vs. Load Current

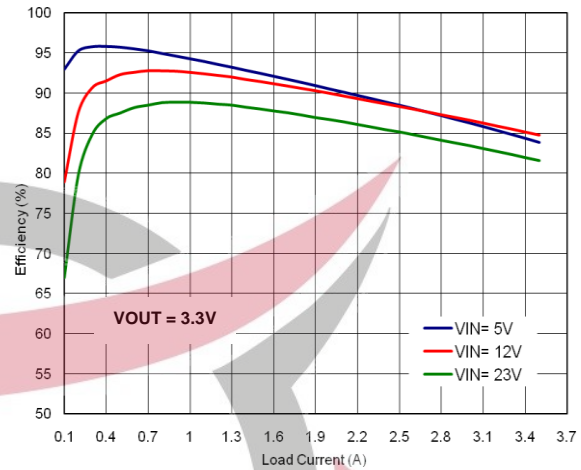

Figure 6. Efficiency vs. Load Current

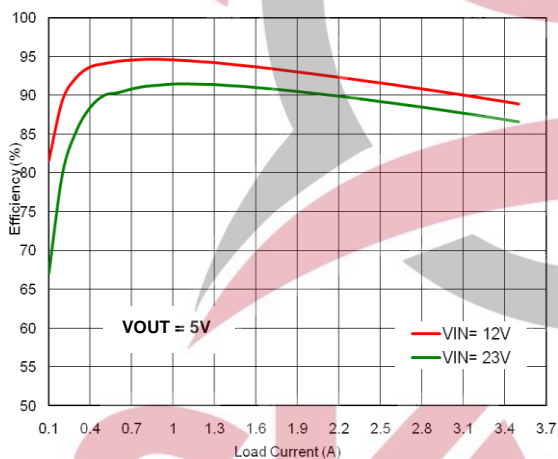

Figure 7. Efficiency vs. Load Current

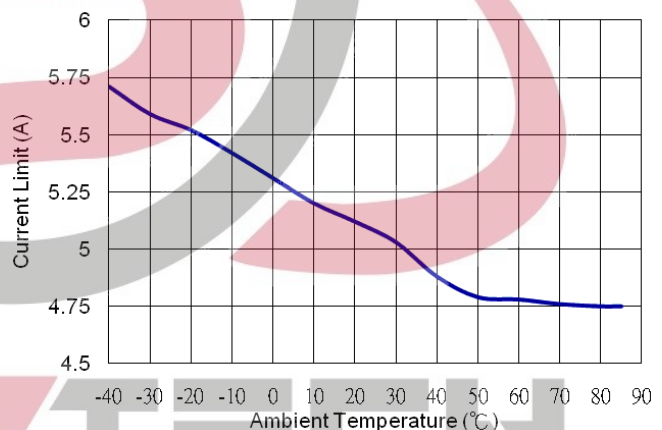

Figure 8. Current Limit vs. Temperature

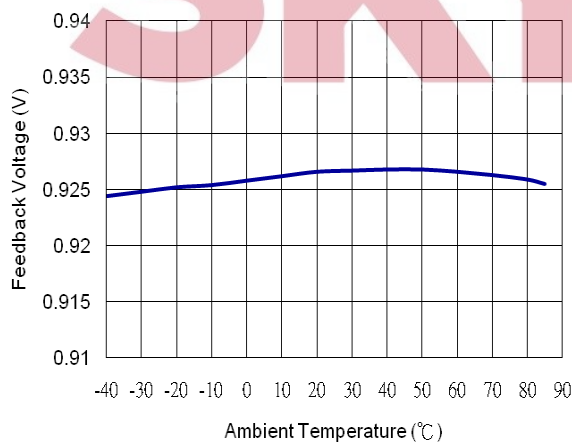

Figure 9. Feedback Voltage vs. Temperature

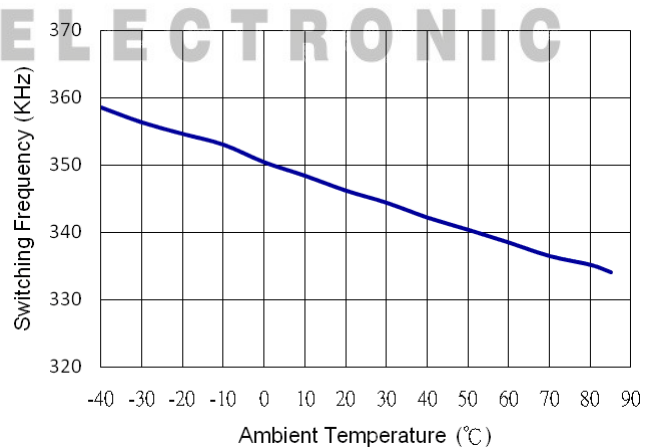

Figure 10. Switching Frequency vs. Temperature

**Typical Performance Curves**

$V_{IN} = 12V$ ,  $V_{OUT} = 3.3V$ ,  $C1 = 10\mu F \times 2$ ,  $C2 = 22\mu F \times 2$ ,  $L1 = 10\mu H$ ,  $T_A = +25^\circ C$ , unless otherwise noted.

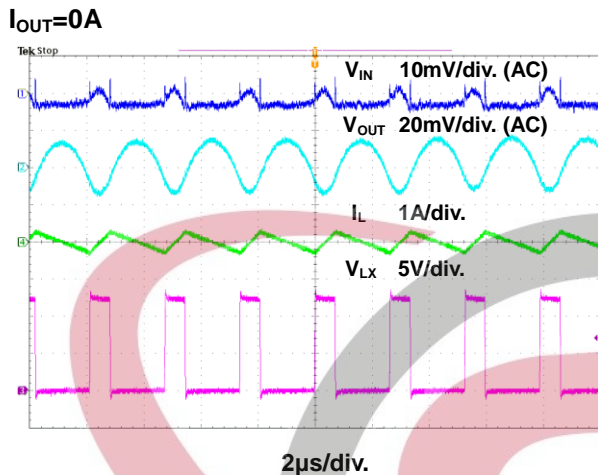

Figure 11. Steady State Waveform

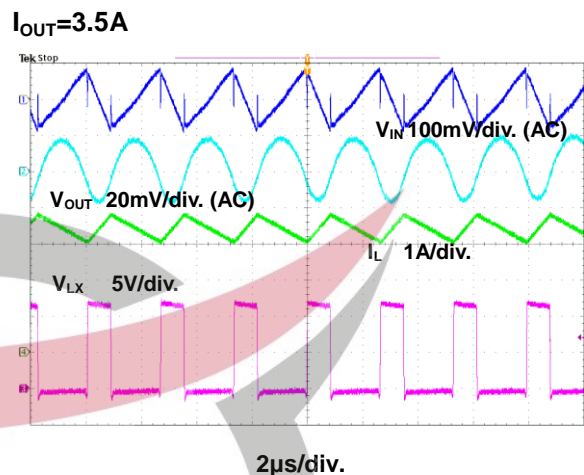

Figure 12. Steady State Waveform

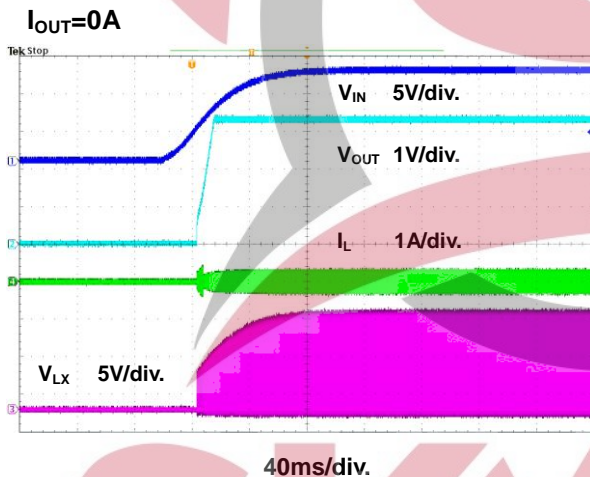

Figure 13. Power On through VIN Waveform

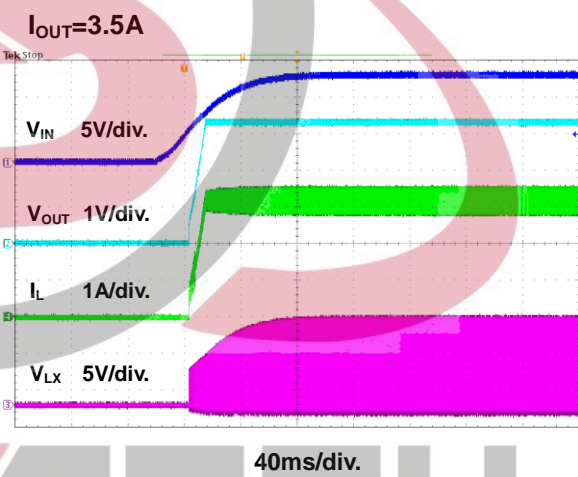

Figure 14. Power On through VIN Waveform

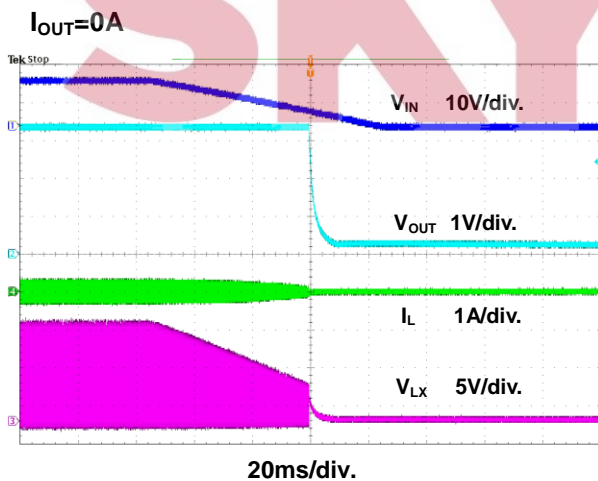

Figure 15. Power Off through VIN Waveform

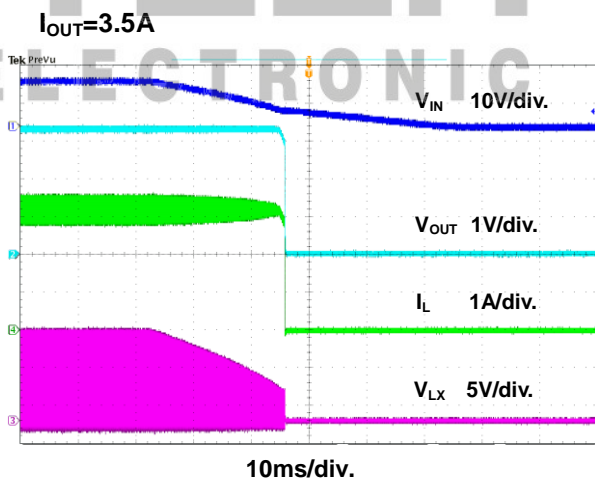

Figure 16. Power Off through VIN Waveform

### Typical Performance Curves

$V_{IN} = 12V$ ,  $V_{OUT} = 3.3V$ ,  $C1 = 10\mu F \times 2$ ,  $C2 = 22\mu F \times 2$ ,  $L1 = 10\mu H$ ,  $T_A = +25^\circ C$ , unless otherwise noted.

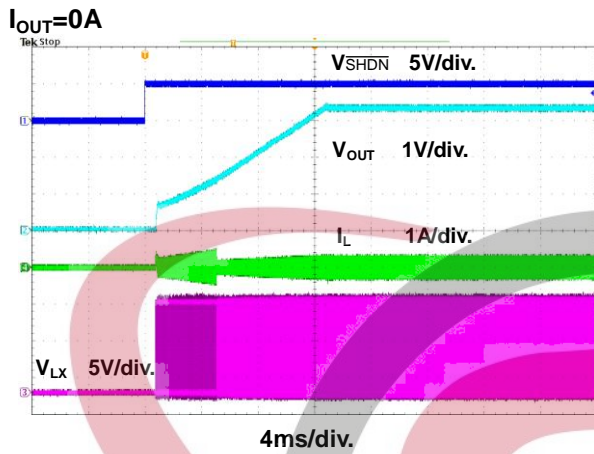

Figure 17. Power On through  $\overline{SHDN}$  Waveform

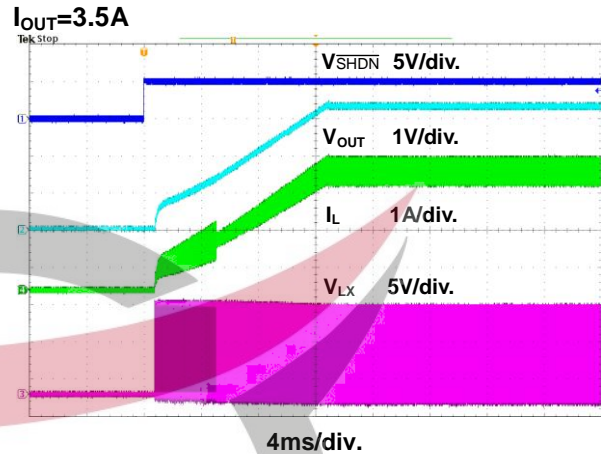

Figure 18. Power On through  $\overline{SHDN}$  Waveform

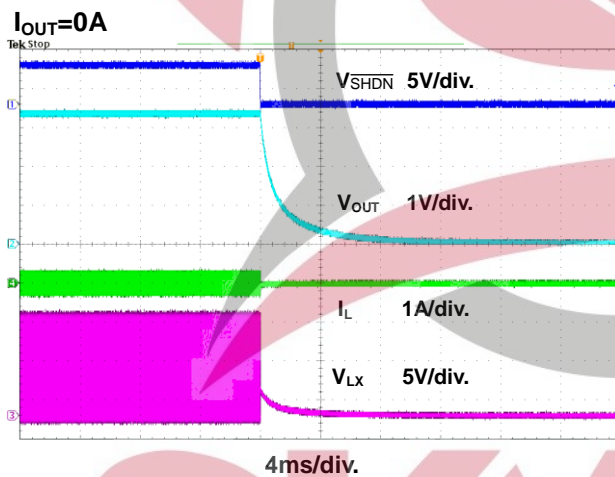

Figure 19. Power Off through  $\overline{SHDN}$  Waveform

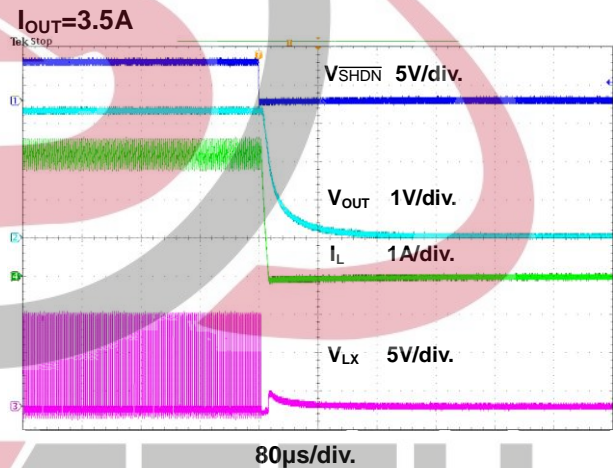

Figure 20. Power Off through  $\overline{SHDN}$  Waveform

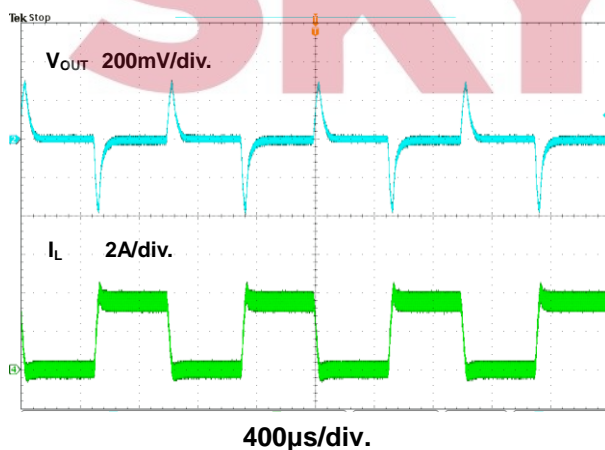

Figure 21. Load Transient Waveform

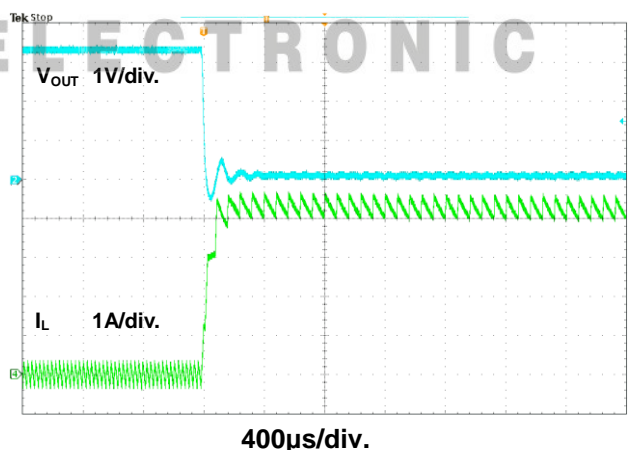

Figure 22. Short Circuit Test



## Function Description

The FR9888 is a high efficiency, internal compensation, and constant frequency current mode step-down synchronous DC/DC converter. It has integrated high-side (110mΩ, typ) and low-side (80mΩ, typ) power switches, and provides 3.5A continuous load current. It regulates input voltage from 4.5V to 23V, and down to an output voltage as low as 0.925V.

### Control Loop

Under normal operation, the output voltage is sensed by FB pin through a resistive voltage divider and amplified through the error amplifier. The voltage of error amplifier output is compared to the switch current to control the RS latch. At the beginning of each clock cycle, the high-side NMOS turns on when the oscillator sets the RS latch, and turns off when current comparator resets the RS latch. Then the low-side NMOS turns on until the clock period ends.

### Enable

The FR9888  $\overline{\text{SHDN}}$  pin provides digital control to turn on/turn off the regulator. When the voltage of  $\overline{\text{v}}$  exceeds the threshold voltage, the regulator starts the soft start function. If the  $\overline{\text{SHDN}}$  pin voltage is below than the shutdown threshold voltage, the regulator will turn into the shutdown mode and the shutdown current will be smaller than 1μA. For auto start-up operation, connect  $\overline{\text{SHDN}}$  to VIN through a 100KΩ resistor.

### Soft Start

The FR9888 employs adjustable soft start function to reduce input inrush current during start up. When the device turns on, a 6μA current begins charging the capacitor which is connected from SS pin to GND. The equation for the soft start time is shown as below:

$$T_{SS} (\text{ms}) = \frac{C_{SS} (\text{nF}) \times V_{FB}}{I_{SS} (\text{uA})}$$

The  $V_{FB}$  voltage is 0.925V and the  $I_{SS}$  current is 6μA. If a 0.1μF capacitor is connected from SS pin to GND, the soft start time will be 15ms.

### Output Over Voltage Protection

When the FB pin voltage exceeds 1.5V, the output over voltage protection function will be triggered and turn off the high-side/low-side MOSFET.

### Input Under Voltage Lockout

When the FR9888 is power on, the internal circuits are held inactive until  $V_{IN}$  voltage exceeds the input UVLO threshold voltage. And the regulator will be disabled when  $V_{IN}$  is below the input UVLO threshold voltage. The hysteric of the UVLO comparator is 250mV (typ).

### Short Circuit Protection

The FR9888 provides short circuit protection function to prevent the device damage from short condition. When the short condition occurs and the feedback voltage drops lower than 0.4V, the oscillator frequency will be reduced to 110KHz to prevent the inductor current increasing beyond the current limit. In the meantime, the current limit will also be reduced to lower the short current. Once the short condition is removed, the frequency and current limit will return to normal.

### Over Current Protection

The FR9888 over current protection function is implemented using cycle-by-cycle current limit architecture. The inductor current is monitored by measuring the high-side MOSFET series sense resistor voltage. When the load current increases, the inductor current also increases. When the peak inductor current reaches the current limit threshold, the output voltage starts to drop. When the over current condition is removed, the output voltage returns to the regulated value.

### Over Temperature Protection

The FR9888 incorporates an over temperature protection circuit to protect itself from overheating. When the junction temperature exceeds the thermal shutdown threshold temperature, the regulator will be shutdown. And the hysteric of the over temperature protection is 60°C (typ).

### Internal Compensation Function

The stability of the feedback circuit is controlled through internal compensation circuits. This internal compensation function is optimized for most applications and this function can reduce external R, C components.

## Application Information

### Output Voltage Setting

The output voltage  $V_{OUT}$  is set using a resistive divider from the output to FB. The FB pin regulated voltage is 0.925V. Thus the output voltage is:

$$V_{OUT} = 0.925V \times \left(1 + \frac{R1}{R2}\right)$$

Table 2 lists recommended values of R1 and R2 for most used output voltage.

**Table 2 Recommended Resistance Values**

$V_{OUT}$	R1	R2
5V	44.2k $\Omega$	10k $\Omega$
3.3V	26.1k $\Omega$	10k $\Omega$
2.5V	16.9k $\Omega$	10k $\Omega$
1.8V	9.53k $\Omega$	10k $\Omega$
1.2V	3k $\Omega$	10k $\Omega$

Place resistors R1 and R2 close to FB pin to prevent stray pickup.

### Input Capacitor Selection

The use of the input capacitor is filtering the input voltage ripple and the MOSFETS switching spike voltage. Because the input current to the step-down converter is discontinuous, the input capacitor is required to supply the current to the converter to keep the DC input voltage. The capacitor voltage rating should be 1.25 to 1.5 times greater than the maximum input voltage. The input capacitor ripple current RMS value is calculated as:

$$I_{IN(RMS)} = I_{OUT} \times \sqrt{D \times (1-D)}$$

$$D = \frac{V_{OUT}}{V_{IN}}$$

Where D is the duty cycle of the power MOSFET.

This function reaches the maximum value at D=0.5 and the equivalent RMS current is equal to  $I_{OUT}/2$ . The following diagram is the graphical representation of above equation.

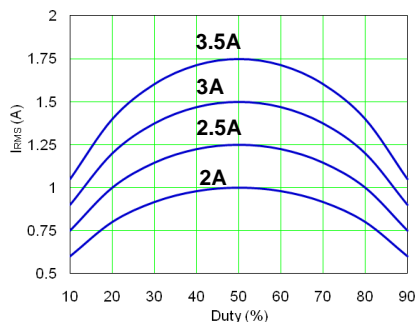

A low ESR capacitor is required to keep the noise minimum. Ceramic capacitors are better, but tantalum or low ESR electrolytic capacitors may also suffice. When using tantalum or electrolytic capacitors, a 0.1 $\mu$ F ceramic capacitor should be placed as close to the IC as possible.

### Output Capacitor Selection

The output capacitor is used to keep the DC output voltage and supply the load transient current. When operating in constant current mode, the output ripple is determined by four components:

$$V_{RIPPLE}(t) = V_{RIPPLE(C)}(t) + V_{RIPPLE(ESR)}(t) + V_{RIPPLE(ESL)}(t) + V_{NOISE}(t)$$

The following figures show the form of the ripple contributions.

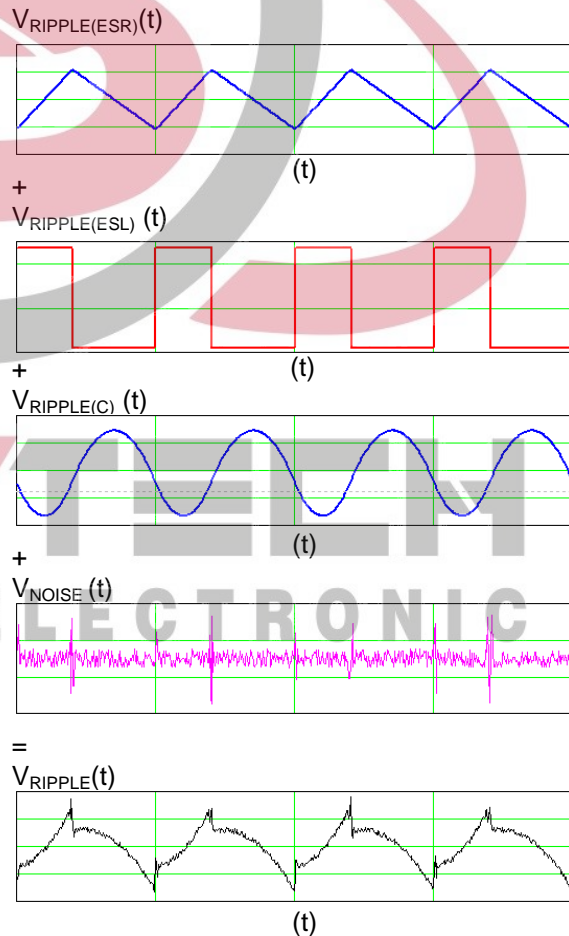

## Application Information

$$V_{\text{RIPPLE(ESR)}} = \frac{V_{\text{OUT}}}{F_{\text{OSC}} \times L} \times \left(1 - \frac{V_{\text{OUT}}}{V_{\text{IN}}}\right) \times \text{ESR}$$

$$V_{\text{RIPPLE(ESL)}} = \frac{\text{ESL}}{L + \text{ESL}} \times V_{\text{IN}}$$

$$V_{\text{RIPPLE(C)}} = \frac{V_{\text{OUT}}}{8 \times F_{\text{OSC}}^2 \times L \times C_{\text{OUT}}} \times \left(1 - \frac{V_{\text{OUT}}}{V_{\text{IN}}}\right)$$

Where  $F_{\text{OSC}}$  is the switching frequency,  $L$  is the inductance value,  $V_{\text{IN}}$  is the input voltage, ESR is the equivalent series resistance value of the output capacitor, ESL is the equivalent series inductance value of the output capacitor and the  $C_{\text{OUT}}$  is the output capacitor.

Low ESR capacitors are preferred to use. Ceramic, tantalum or low ESR electrolytic capacitors can be used depending on the output ripple requirement. When using the ceramic capacitors, the ESL component is usually negligible.

It is important to use the proper method to eliminate high frequency noise when measuring the output ripple. The figure shows how to locate the probe across the capacitor when measuring output ripple. Removing the scope probe plastic jacket in order to expose the ground at the tip of the probe. It gives a very short connection from the probe ground to the capacitor and eliminating noise.

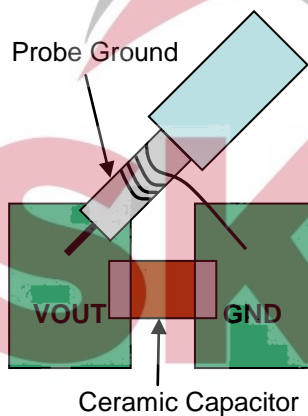

### Inductor Selection

The output inductor is used for storing energy and filtering output ripple current. But the trade-off condition often happens between maximum energy storage and the physical size of the inductor. The first consideration for selecting the output inductor is to make sure that the inductance is large enough to keep the converter in the continuous current mode.

That will lower ripple current and result in lower output ripple voltage. The  $\Delta I_L$  is inductor peak-to-peak ripple current:

$$\Delta I_L = \frac{V_{\text{OUT}}}{F_{\text{OSC}} \times L} \times \left(1 - \frac{V_{\text{OUT}}}{V_{\text{IN}}}\right)$$

The following diagram is an example to graphical represent  $\Delta I_L$  equation.

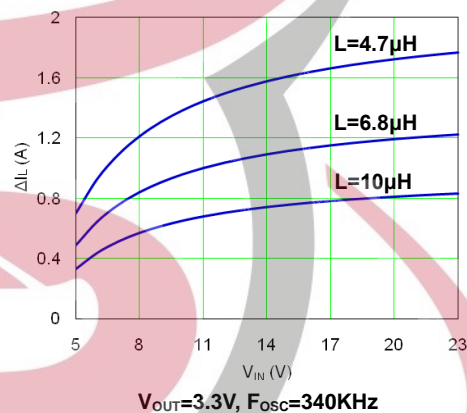

A good compromise value between size and efficiency is to set the peak-to-peak inductor ripple current  $\Delta I_L$  equal to 30% of the maximum load current. But setting the peak-to-peak inductor ripple current  $\Delta I_L$  between 20%~50% of the maximum load current is also acceptable. Then the inductance can be calculated with the following equation:

$$\Delta I_L = 0.3 \times I_{\text{OUT(MAX)}}$$

$$L = \frac{(V_{\text{IN}} - V_{\text{OUT}}) \times V_{\text{OUT}}}{V_{\text{IN}} \times F_{\text{OSC}} \times \Delta I_L}$$

To guarantee sufficient output current, peak inductor current must be lower than the FR9888 high-side MOSFET current limit. The peak inductor current is as below:

$$I_{\text{PEAK}} = I_{\text{OUT(MAX)}} + \frac{\Delta I_L}{2}$$

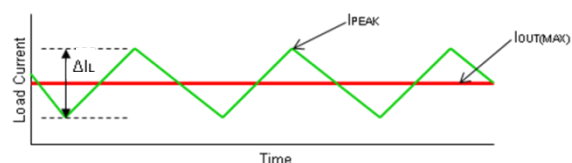

## Application Information

### Feedforward Capacitor Selection

Internal compensation function allows users saving time in design and saving cost by reducing the number of external components. The use of a feedforward capacitor C6 in the feedback network is recommended to improve the transient response or higher phase margin.

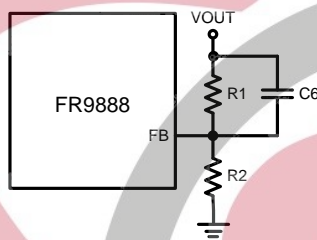

For optimizing the feedforward capacitor, knowing the cross frequency is the first thing. The cross frequency (or the converter bandwidth) can be determined by using a network analyzer. When getting the cross frequency with no feedforward capacitor identified, the value of feedforward capacitor C6 can be calculated with the following equation:

$$C6 = \frac{1}{2\pi \times F_{CROSS}} \times \sqrt{\frac{1}{R1} \times \left(\frac{1}{R1} + \frac{1}{R2}\right)}$$

Where  $F_{CROSS}$  is the cross frequency.

To reduce transient ripple, the feedforward capacitor value can be increased to push the cross frequency to higher region. Although this can improve transient response, it also decrease phase margin and cause more ringing. In the other hand, if more phase margin is desired, the feedforward capacitor value can be decreased to push the cross frequency to lower region. In general, the feedforward capacitor range is between 10pF to 1nF.

### External Diode Selection

For 5V input applications, it is recommended to add an external boost diode. This helps improving the efficiency. The boost diode can be a low cost one such as 1N4148.

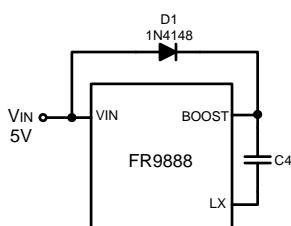

### PCB Layout Recommendation

The device's performance and stability is dramatically affected by PCB layout. It is recommended to follow these general guidelines show as below:

1. Place the input capacitors and output capacitors as close to the device as possible. Trace to these capacitors should be as short and wide as possible to minimize parasitic inductance and resistance.
2. Place feedback resistors close to the FB pin.
3. Keep the sensitive signal (FB) away from the switching signal (LX).
4. The exposed pad of the package should be soldered to an equivalent area of metal on the PCB. This area should connect to the GND plane and have multiple via connections to the back of the PCB as well as connections to intermediate PCB layers. The GND plane area connecting to the exposed pad should be maximized to improve thermal performance.
5. Multi-layer PCB design is recommended.

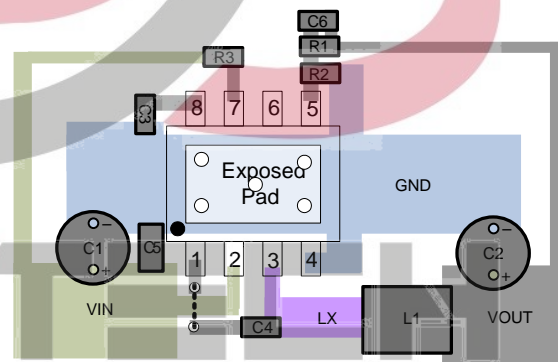
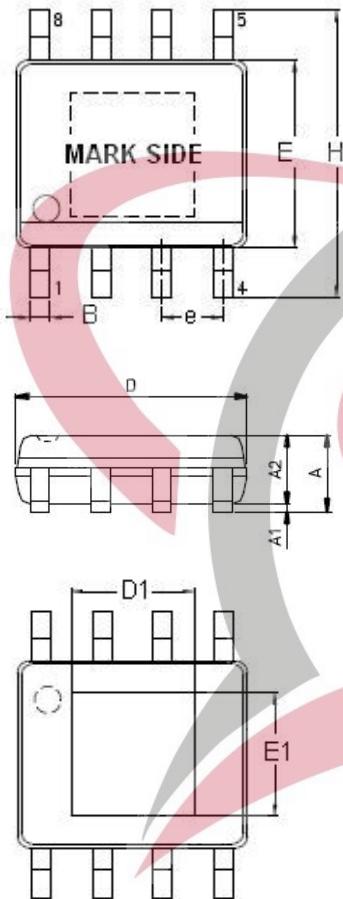

Figure 23. FR9888 SOP-8(Exposed Pad) package  $C_{IN}/C_{OUT}$  with EC capacitors Recommended PCB Layout Diagram

**Outline Information**

**SOP-8 (Exposed Pad) Package (Unit: mm)**



SYMBOLS UNIT	DIMENSION IN MILLIMETER	
	MIN	MAX
A	1.25	1.70
A1	0.00	0.15
A2	1.25	1.55
B	0.31	0.51
D	4.80	5.00
D1	3.04	3.50
E	3.80	4.00
E1	2.15	2.41
e	1.20	1.34
H	5.80	6.20
L	0.40	1.27

Note : Followed From JEDEC MO-012-E.

**Carrier dimensions**

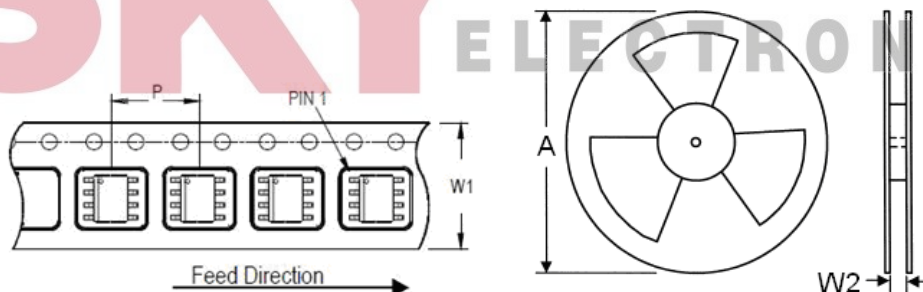

Tape Size (W1) mm	Pocket Pitch (P) mm	Reel Size (A)		Reel Width (W2) mm	Empty Cavity Length mm	Units per Reel
		in	mm			
12	8	13	330	12.4	400~1000	2,500

**Life Support Policy**

Fitipower's products are not authorized for use as critical components in life support devices or other medical systems.